

WHITE PAPER

Enabling Long-Range and Low-Power IoT Applications



**Using Long Range (LoRa) and Bluetooth® Low
Energy Wireless Technology**

Contents

- Executive Summary 4**

- Introduction 6**
 - What is the Internet of Things? 6
 - How Do We Enable IoT? 8

- Market Conditions and Trends 10**
 - Wireless Communication Technologies for IoT Applications 11

- Why Use Bluetooth Low Energy and LoRa Together? 12**
 - Enter LoRa and LoRaWAN 12
 - Enabling Low-Power IoT Applications 13

- Why Not Conventional Solutions? 15**
 - Meeting Today’s IoT Demands 15

- A Better Way to Deploy IoT 16**

- IoT Use Cases for Bluetooth Low Energy and LoRA 17**
 - Public Facilities 17
 - Secure Storage 18
 - Water Leak Detection 19
 - Cold Chain Monitoring 21

- Choosing the Right OEM Partner for IoT Solution 23**
 - Scalability 23
 - Energy Efficiency 23
 - Edge Intelligence 23
 - Cost 24
 - Security 24
 - Form Factor 24

Conclusion 25

About the Company 26

 Northern Mechatronics 26

 Ambiq 26

Executive Summary

With the rapid expansion of the Internet of Things (IoT), digital sensors and networking technologies are increasingly utilized to connect devices and systems for more applications. On the consumer front, most people are already used to IoT-enabled products such as smart speakers, smart doorbells, lighting and temperature controls, and security surveillance systems in a smart home.

The key technologies that enable IoT in consumer use cases and smart homes are wireless technologies like Wi-Fi, Bluetooth, and new 5G. Commercial and Industrial IoT applications, on the other hand, have different requirements to maximize their productivity and return-on-investment (ROI).

Among all the available wireless protocols, the most popular and prevalent technologies are Bluetooth® Low Energy and LoRa (Long Range). The combination of Bluetooth Low Energy, which is intended for short-range networks, and LoRa, which is ideal for low power wide-area networks, is a perfect solution for easily and securely deploying IoT applications.

Market Conditions and Trends

Beyond making our daily lives more convenient and hassle-free, IoT has driven digital transformation across Industrial IoT (IIoT) and Enterprise IoT (EIoT) settings. IIoT has enabled automation and data exchange in manufacturing, spurring on the “Fourth Industrial Revolution,” or Industry 4.0¹. Increasingly, Industry 4.0 is making manufacturing more intelligent and connected with smart factories.

Traditionally, most IoT deployments happen close to a telecommunication infrastructure, usually located in a city or a town. However, IoT devices and sensors deployed in remote locations pose logistical challenges for maintenance and battery life. These IoT deployments are often inaccessible for field technicians, and there could be hundreds of deployed sensors in a factory, making it impractical to check each one manually. To meet these demands, industry leaders leverage the latest wireless trends and technologies such as Bluetooth Low Energy and LoRa.

Why Use Bluetooth Low Energy and LoRa Together?

Bluetooth Low Energy and LoRa complement each other’s strengths, making them ideal for a variety of applications. Until recently, Bluetooth Low Energy usage was limited to low throughput endpoints like beacons and wearables. However, the latest Bluetooth 5.0 can send large data files or stream audio without quickly draining the device battery. On the other hand, LoRa fulfills the need for low-cost and widely deployed sensors that need to send tiny data packets over a long distance.

Bluetooth Low Energy and LoRa are crucial requirements that make up a complete wireless solution for low-power IoT applications. Bluetooth Low Energy addresses low power short-range connectivity, while LoRa addresses low power long-range connectivity. The other requirement is an ultra low-power system on chip (SoC). SoCs such as the Ambiq® Apollo3 Blue can handle the low power edge compute needed to support real-time applications. Together, these technologies enable reliable, secure, and energy efficient IoT deployments worldwide.

¹https://en.wikipedia.org/wiki/Fourth_Industrial_Revolution

Why Not Conventional Solutions?

Traditionally, IoT deployments have been dependent on nearby telecommunication infrastructures. However, this restricted IoT devices to a physical network that needed Ethernet, fiber optic cables, and cell towers to send data wirelessly. The reliance on a physical infrastructure also meant that IoT devices couldn't be deployed in remote areas reliably or cheaply.

Telecom connectivity via wire lines or cell tower signals is not always available, and it's often too expensive to build the telecom infrastructure onsite. The cost of sending field service technicians for regular maintenance and battery replacement adds up quickly. Not to mention, it's impossible to manage hundreds or potentially thousands of sensors in different locations without the right technology solutions.

A Better IoT Solution

Rapid tech advances and a competitive market may have left businesses wondering where to find a secure and cost-effective solution to deploy IoT remotely and reliably without relying on existing telecom infrastructure. Northern Mechatronics, a leading wireless module provider, has a solution that enables widespread IoT deployments for commercial and industrial applications.

Northern Mechatronics' NM180100 module leverages both Bluetooth Low Energy and LoRa to offer a global IoT solution ideal for long-range and low-power applications. The module has already secured design wins in mission-critical applications, such as industrial machine health monitoring, delivery lockbox, and livestock health monitoring.

By combining the transmit power of LoRa with the processing power of Ambiq's Apollo3 Blue, the NM180100 meets the ultra-low-power and edge computing requirements for remote deployment. Essentially, Ambiq's industry-leading processor technology is empowering Northern Mechatronic's solution for many practical and vital IoT applications.

Introduction

In recent years, the Internet of Things (IoT) has driven innovation in data analytics, automation, and artificial intelligence in consumer and industrial sectors.

The concept of combining computers, sensors, and networks to monitor and control devices have existed for decades, but recent trends in the digital space are making the internet of things more accessible.

Thanks to the advancement of ultra-low-power solutions, there will soon be billions of devices that enable a hyperconnected world. However, without wireless network technologies like Bluetooth Low Energy or modulation technologies like Long Range (LoRa) that make up long range wide area networks (LoRaWAN), IoT deployments would not be possible.

“However, without wireless network technologies like Bluetooth Low Energy or modulation technologies like Long Range (LoRa) that make up long range wide area networks (LoRaWAN), IoT deployments would not be possible.”

This white paper will review LoRa and its benefits, consider current trends, and discuss how Bluetooth Low Energy and LoRa support IoT applications. This report will then examine why LoRa and LoRaWAN are gaining traction in the IoT and LPWAN ecosystems. Finally, this paper will examine Bluetooth Low Energy and LoRa use cases, focusing on applications featuring self-aware physical topology, low-power capillary networks, and complex remote installations.

What is the Internet of Things?

The Internet of Things refers to scenarios where objects are embedded with sensors, software, and other technologies that enable network connectivity and computing capability. These objects connect and exchange data with other devices and systems over the internet with minimal human intervention¹.

With the rapid expansion of IoT, digital sensors and networking technologies are increasingly utilized to connect devices and systems for more applications. IoT devices range from typical household objects to sophisticated industrial tools.

¹https://en.wikipedia.org/wiki/Internet_of_things

Figure 1: Total Number of Device Connections (including Non-IoT)

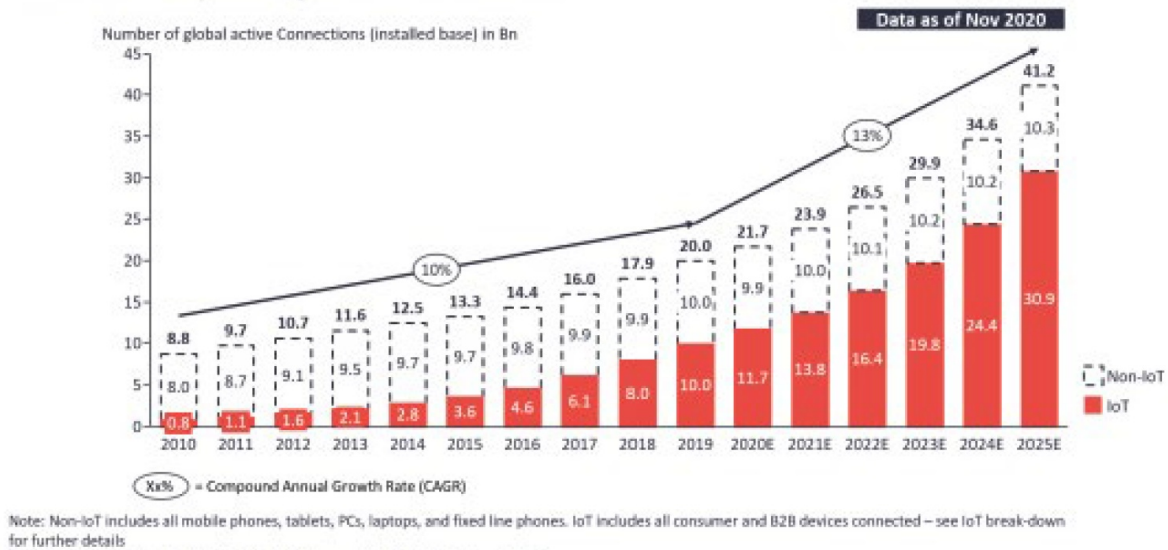

Currently, there are 11.7 billion devices connected to the internet¹. This figure is expected to nearly triple by 2025. On the consumer market, IoT is closely associated with connected products such as smart speakers, smart doorbells, lighting and temperature controls, and security surveillance systems in a smart home.

Commercial IoT solutions include building access and connected lighting, and they can be deployed in public spaces such as office buildings, hotels, stores, healthcare facilities, or entertainment venues. Industrial IoT solutions, such as low-energy sensors, can augment existing factory automation systems by relaying raw data to the enterprise cloud; thereby providing actionable intelligence through data analytics and insights.

“Industrial IoT solutions, such as low-energy sensors, can augment existing factory automation systems by relaying raw data to the enterprise cloud; thereby providing actionable intelligence through data analytics and insights.”

Beyond providing actionable intelligence, IoT applications can have an enormous impact on cost savings. Industry requires energy, which plays a major role in manufacturing and distributing costs. Through smart sensors and technology, companies can cut back on IoT deployment and maintenance costs. In factories and other industrial settings, even minor reductions in energy usage can translate to substantial savings that outweigh the cost of IoT devices and infrastructure.

¹<https://iot-analytics.com/state-of-the-iot-2020-12-billion-iot-connections-surpassing-non-iot-for-the-first-time/>

How Do We Enable IoT?

By combining objects with internet connectivity and data analytics, IoT is transforming the way we live, work, and play. However, the internet of things is only possible with powerful wireless technologies, both short range and long range.

Figure 2: Wireless Technologies for IoT with Bandwidth and Signal Coverage

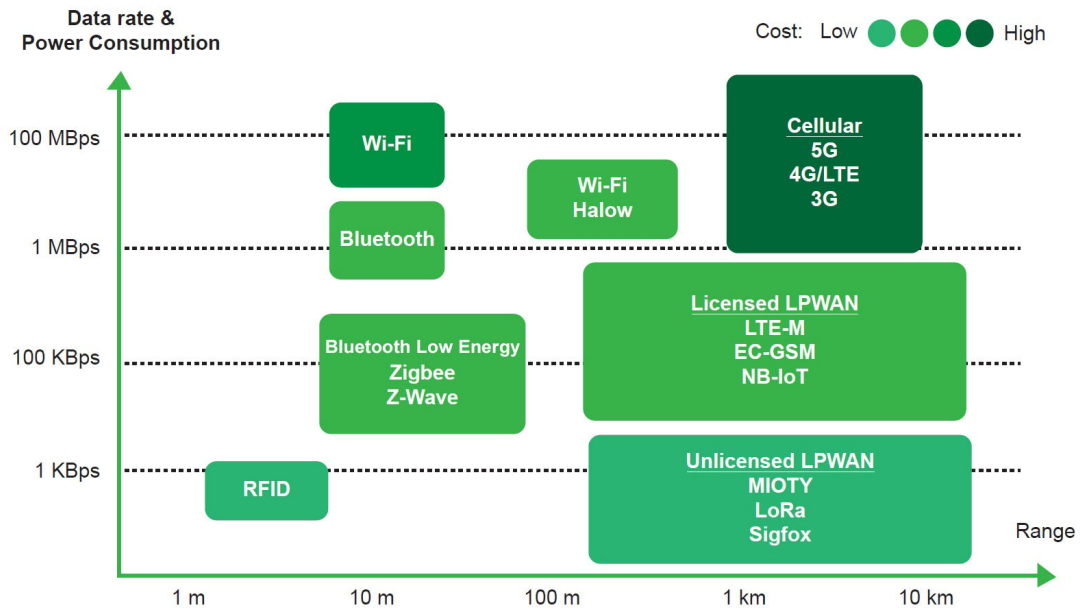

The key technologies that enable IoT in consumer use cases and smart homes are wireless network protocols like Wi-Fi, Bluetooth, and new 5G. Commercial and industrial IoT applications, on the other hand, have different requirements to maximize their productivity and return-on-investment (ROI).

For commercial and industrial IoT applications, the most popular and prevalent technologies are Bluetooth Low Energy and LoRa (Long Range). Bluetooth Low Energy is best for short range networks while LoRa is perfect for low power wide-area networks. If commercial and industrial businesses are seeking a way to easily and securely deploy IoT applications, then the combination of Bluetooth Low Energy and LoRa makes for an ideal solution.

Figure 3: A Typical Bluetooth Low Energy Network for IoT Applications

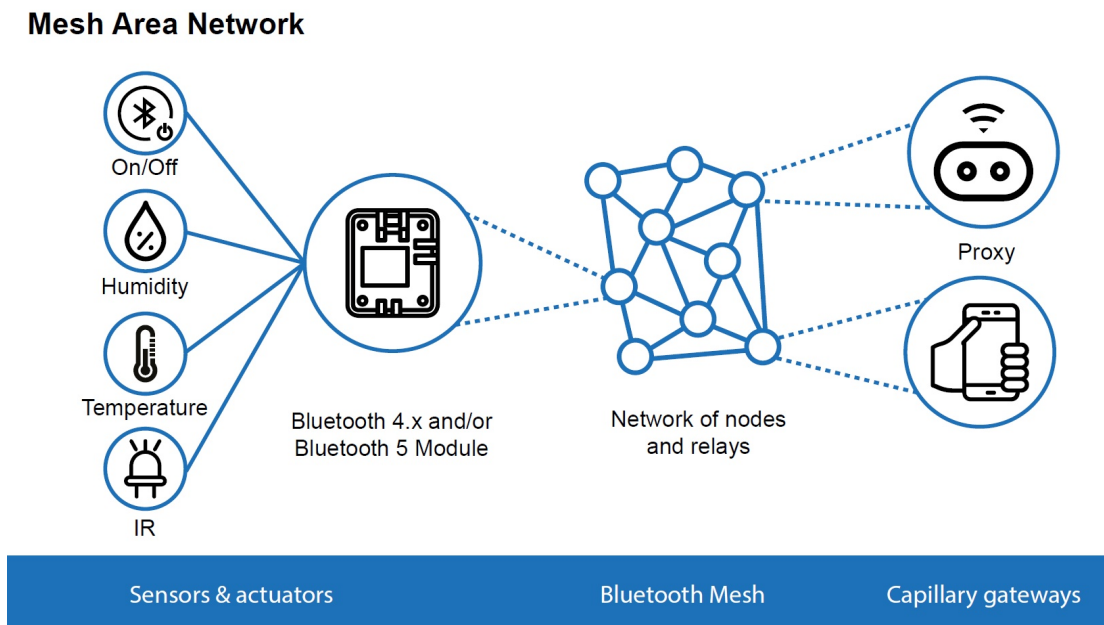
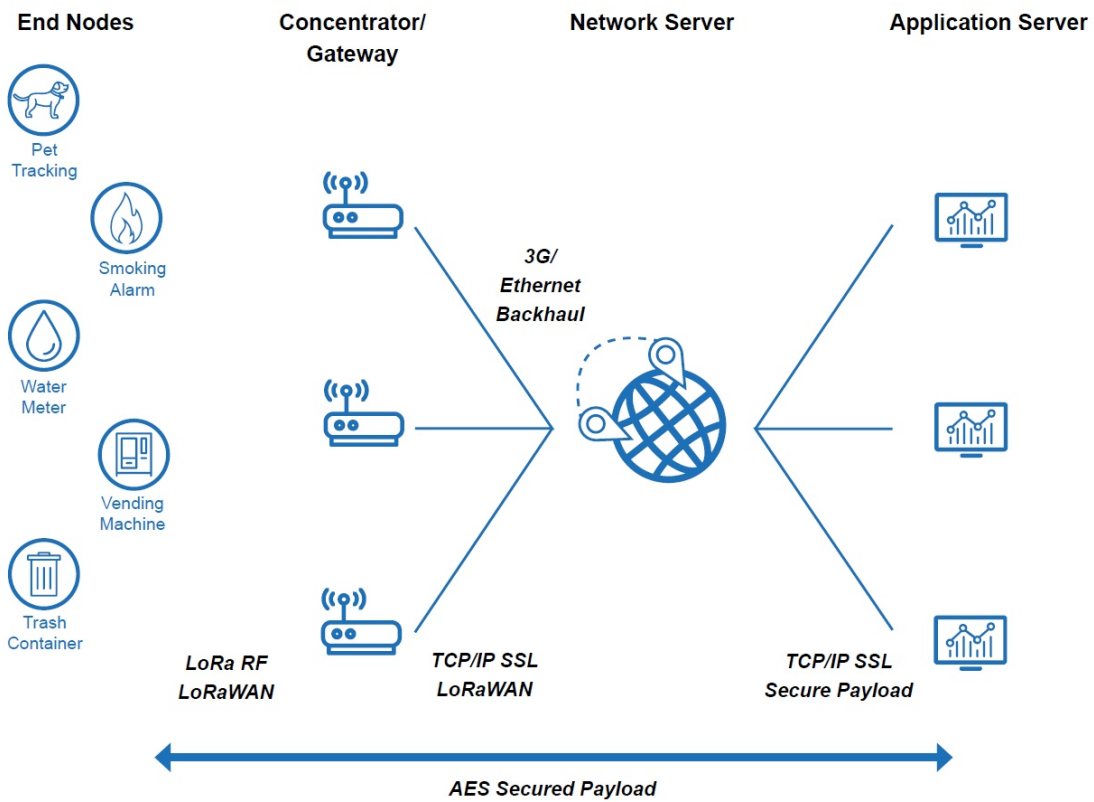

Figure 4: A Typical LoRA Network for IoT Applications



Market Conditions and Trends

While the term “Internet of Things” was not coined until 1999¹, the concept of combining computers and networks to control and monitor devices has existed for decades. By the late 1970s, there were already systems for remotely monitoring meters on electrical grids in commercial use². A few decades later, wireless technologies like the Internet allowed “machine-to-machine” communication to become widely possible.

Today, the Internet of Things (IoT) is widely recognized as a significant digital trend with major economic, social, and technical impact. Specifically, four factors have contributed to taking IoT to its current state:

1. **Low cost and high-speed connectivity** becoming easily accessible, with connectivity costs decreasing and bandwidth increasing at the same time
2. **Internet protocol networking** has become the dominant global standard, leading to the widespread adoption of IP-based networking for software on many devices
3. **Moore’s Law** pushes the industry to deliver increasing computing power at a lower price while consuming less power
4. New algorithms and rapid improvements in computing power, data storage, and cloud services enables the **analysis and correlation of large datasets**

Increasingly, Industry 4.0 is making manufacturing more intelligent and connected with smart factories. In the wake of the COVID-19 pandemic, more technology leaders are implementing Industrial IoT solutions to maintain business continuity and ensure employee safety and security³.

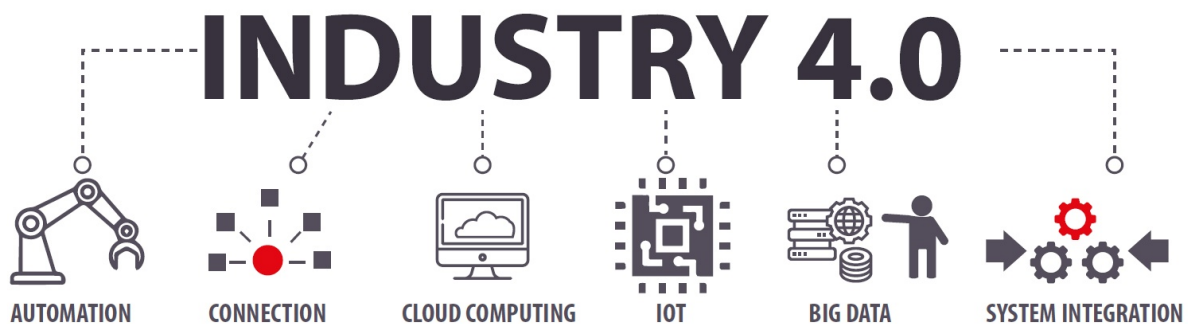

¹<https://blog.avast.com/kevin-ashton-named-the-internet-of-things>

²<https://electricenergyonline.com/energy/magazine/491/article/A-Brief-History-of-Electric-Utility-Automation-Systems.html>

³<https://www.mckinsey.com/industries/advanced-electronics/our-insights/coronavirus-industrial-iiot-in-challenging-times>

Wireless Communication Technologies for IoT Applications

Traditionally, most IoT deployments happen close to a telecommunication infrastructure, usually located in a city or a town. IoT devices can connect to existing cellular networks using LTE-M or NB-IoT protocols¹. These protocols are low-bandwidth, low-power, low-cost, and ideal for connecting IoT devices to cellular networks.

Typical IoT-enabled products are powered by portable battery or by plugging into an AC wall outlet. However, IoT devices and sensors deployed in remote locations pose logistical challenges for both battery life and maintenance. Remote IoT deployments are often inaccessible for field technicians, and there could be hundreds of deployed sensors in a factory, making it impractical to check each one manually.

“Remote IoT deployments are often inaccessible for field technicians, and there could be hundreds of deployed sensors in a factory, making it impractical to check each one manually.”

To meet these demands, industry leaders leverage the latest wireless trends and technologies such as Bluetooth Low Energy and LoRa. By blending these wireless communication technologies, we can deploy IoT applications in remote locations more efficiently at a cheaper cost, thereby opening new opportunities.

¹<https://www.sdxcentral.com/5g/iot/definitions/telecom-using-iot/>

Why Use Bluetooth Low Energy and LoRa Together?

The future of IoT lies out on the edge where sensor device-to-cloud wireless connectivity does not have to rely on the communication infrastructures of cities.

Increasingly, wireless networking technologies such as Bluetooth Low Energy¹ are already a fundamental component of many IoT applications. Thanks to Bluetooth Low Energy's small footprint and energy-efficient architecture, it enables small wireless sensors and controls to operate on a battery charge for years on IoT networks. Unlike traditional wired devices, users can place Bluetooth Low Energy enabled devices in nearly any location without worrying about physical accessibility, technical difficulty, or financial practicality.

“Thanks to Bluetooth Low Energy’s small footprint and energy-efficient architecture, it enables small wireless sensors and controls to operate on a battery charge for years on IoT networks.”

However, Bluetooth Low Energy devices need a wireless backhaul to transmit the collected data to a central network or another physical site. Engineers and analysts need to be able to review the data and send back instructions if necessary. That’s why most Bluetooth Low Energy IoT applications rely on a mobile phone’s cellular connection as a gateway back to the cloud. But what happens if a cellular network isn’t reachable?

Enter LoRa and LoRaWAN

LoRa wireless RF technology comes in handy for IoT applications across a low-power wide-area network (LPWAN), LoRa² (Long Range) is a wireless transceiver and a modulation technique from Semtech. Essentially, LoRa can translate data into a RF signal that can be sent and received over the air to enable a long-range communication link.

The LoRa modulation technology makes up the physical layer of LoRaWAN, a software protocol based on LoRa. Together, LoRa and LoRaWAN enable long-range connectivity for IoT devices across industrial applications³. LoRaWAN is a standard that defines the communication protocol between a sensor node and a gateway. It is widely employed over the globe with major deployment in the US, Europe, and China.

¹https://en.wikipedia.org/wiki/Bluetooth_Low_Energy

²<https://en.wikipedia.org/wiki/LoRa>

³<https://medium.com/coinmonks/lpwan-lora-lorawan-and-the-internet-of-thingsaed7d5975d5d>

Figure 5: A Simple Geographic Setup of a Long-Range Enterprise IoT Scenario

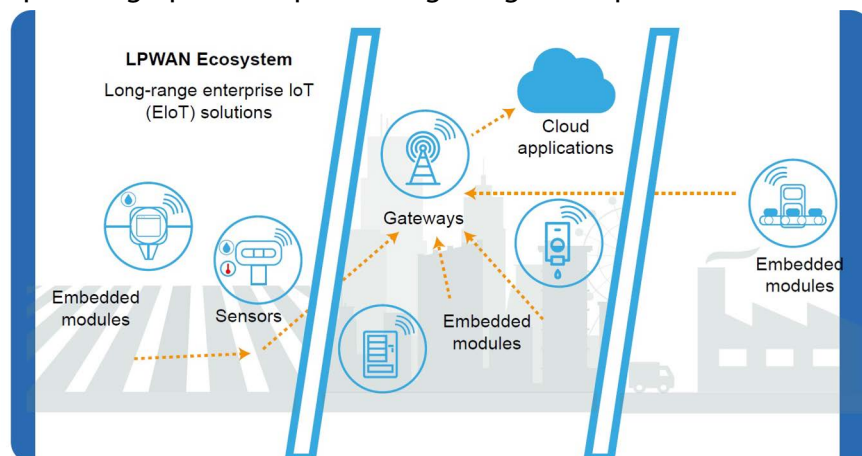

LoRa enables long-range communications up to 10 miles in line-of-sight conditions and has deep penetration capability through concrete and foliage. The ultra-low power requirements enable battery-powered devices to last more than 5 years. Compared to other modulation schemes, LoRa is extremely energy efficient and resilient to interference. The combination of small receive bandwidth and a unique coding scheme allows LoRa radios to achieve a receiver sensitivity of as low as -140dBm. These qualities make LoRa-based solutions ideal for applications that require long-range communication among many devices that have low power requirements and that collect small amounts of data¹.

Enabling Low-Power IoT Applications

Bluetooth Low Energy and LoRa complement each other's strengths, making them ideal for a variety of applications. Until recently, Bluetooth Low Energy usage was limited to low throughput endpoints like beacons and wearables. However, the latest Bluetooth 5.0 can send large data files or stream audio without quickly draining the device battery. On the other hand, LoRa fulfills the need for low-cost and widely deployed sensors that need to send tiny data packets over a long distance.

Bluetooth Low Energy and LoRa are crucial requirements that make up a complete wireless solution for low-power IoT applications. Bluetooth Low Energy addresses low power short-range connectivity, while LoRa addresses low power long-range connectivity. The other requirement is an ultra-low-power system on chip (SoC). SoCs such as the Ambiq Apollo3 Blue can handle the low power edge compute needed to support real-time applications. Together, these technologies enable reliable, secure, and energy efficient IoT deployments worldwide.

Figure 6: Ambiq Apollo3 Blue SoC - front and back

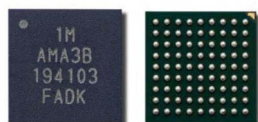

¹<https://lora-developers.semtech.com/library/tech-papers-and-guides/lora-andlorawan/>

Why Not Conventional Solutions?

Traditionally, IoT deployments have been dependent on nearby telecommunication infrastructures. IoT devices need to be within arm's reach of networks, whether in the form of wired infrastructure or wireless towers. However, this restricted IoT devices to a physical network that needed Ethernet, fiber optic cables, and cell towers to send data wirelessly.

The reliance on a physical infrastructure also meant that IoT devices couldn't be deployed in remote areas reliably or cheaply. Telecom connectivity via wire lines or cell tower signals is not always available, and it's often too expensive to build the telecom infrastructure onsite. Industrial IoT deployments typically come in the form of battery-operated devices placed in rural locations, meaning they need a reliable connection.

Relying on existing telecom infrastructure is not a viable strategy for low-power and long-range IoT deployments. Not only is it geographically limiting, but it costs more for regular maintenance. The cost of sending field service technicians for regular maintenance and battery replacement adds up quickly¹. Not to mention, it's impossible to manage hundreds or potentially thousands of sensors in different locations without the right technology solutions.

Meeting Today's IoT Demands

Industrial IoT connections are projected to see a fivefold increase between 2016 and 2025, from 2.4 billion to nearly 14 billion connections². Low-Power, Wide-Area Networks (LPWAN) such as LoRaWAN are expected to support many of the billions of devices that will be used for industrial applications.

These devices are crucial for monitoring and information relay of remote industrial equipment, pipelines, energy tanks, soil, and moisture³. LoRaWAN is ideal for use cases where periodic data need to be transferred over long distances for a long time, optimizing LPWANs for range, capacity, battery lifetime, and cost. Before the rise of LPWAN technologies, use cases such as monitoring the availability of parking places, measuring the moisture level in the ground for automated irrigation systems, or tracking wildlife in nature were difficult or impractical to implement.

However, LoRa enables low-cost, battery-powered devices to send very small packets of data over a long distance. In particular, the scalability of LoRa technology makes it particularly suited for the mass deployment of end devices such as sensors and actuators in remote locations.



¹<https://r-stylelab.com/company/blog/iot/internet-of-things-how-much-does-it-cost-to-build-iot-solution>

²<https://www.iiot-now.com/2019/05/22/96056-low-power-wide-area-network-market-valued-us65bn-2025-gmi-report-says/>

³<https://www.mwrf.com/technologies/systems/article/21848379/lorable-puts-iioteverywhere-on-the-map>

A Better Way to Deploy IoT

Rapid tech advances and a competitive market may have left businesses wondering where to find a secure and cost-effective solution to deploy IoT remotely and reliably without relying on existing telecom infrastructure.

Fortunately, there is a solution that enables widespread IoT deployments for commercial and industrial applications from Northern Mechatronics, a leading wireless module provider. Specifically, Northern Mechatronics' NM180100 module leverages both Bluetooth Low Energy and LoRa to offer a global IoT solution ideal for long-range and low-power applications.

“Specifically, Northern Mechatronics' NM180100 module leverages both Bluetooth Low Energy and LoRa to offer a global IoT solution ideal for long-range and low-power applications.”

The NM180100 module has a wireless range of up to 12 miles (20 km) while using 10x less power than comparable products. The module has enough flash and RAM for any IoT application, and it has already secured design wins in mission-critical applications, such as industrial machine health monitoring, security application, and agricultural applications.

“The module has enough flash and RAM for any IoT application, and it has already secured design wins in mission-critical applications, such as industrial machine health monitoring, security application, and agricultural applications.”

By combining the transmit power of LoRa with the processing power of Ambiq's Apollo3 Blue, the NM180100 meets the ultra-low-power and edge computing requirements for remote deployment. Ambiq's industry-leading processor technology is empowering Northern Mechatronic's solution for many practical and vital IoT applications. No matter where it is deployed in the world, the NM180100 can be counted on for its reliability, efficiency, and security.

Figure 7: Northern Mechtronics NM180100



IoT Use Cases for Bluetooth Low Energy and LoRa

As more IoT devices come equipped with Bluetooth Low Energy and LoRa capabilities, new use cases are being unlocked across a variety of commercial and industrial sectors. Specifically, Northern Mechatronics' IoT module opens the door to a variety of applications, including public facilities, secure storage, water leak detection, and cold chain monitoring:



Public Facilities

Public facilities, such as washrooms in an airport or a shopping mall, can leverage Bluetooth Low Energy and LoRa to clean and resupply efficiently. The typical maintenance operation consists of a regular schedule of cleaning and supply replenishment. However, in areas with high foot traffic, consumables such as soap or toilet paper may be used up before the next scheduled cleaning. Not only does this cause frustration to the patrons, but it is also a potential health hazard.

The COVID-19 pandemic has made the high availability of soaps and toilet paper a necessity for places such as schools, factories, and shopping malls. But how can the cleaning staff be alerted when the supply reserve is running low? By deploying sensors in the dispensing machines. For example, the soap dispenser can contain a fluid level sensor. When the remaining soap drops under a certain threshold, a notification is sent over Bluetooth Low Energy. These sensors eliminate any guesswork on which machines need refilling, saving the cleaning staff invaluable trips.

Figure 8: Use Case: Aggregate and Delay

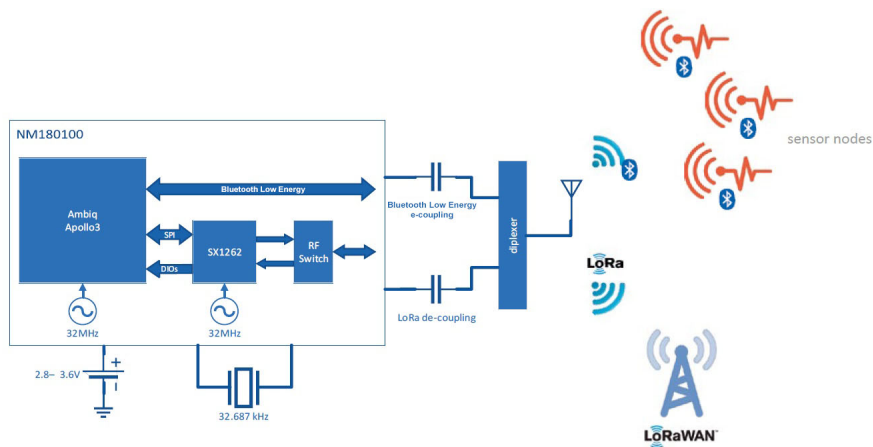

To maintain long battery life while keeping the costs low, these sensors would comprise of a Bluetooth Low Energy radio and a sensing element. A sensor gateway with Bluetooth Low Energy radio and a LoRa transceiver, such as the NM180100, can then aggregate all the Bluetooth Low Energy data and relay it to the backend server over LoRaWAN. This is an example of a capillary network where a short-range radio, Bluetooth Low Energy, is used to provide local connectivity

and the connection to the global communication infrastructure is achieved through a LoRaWAN gateway with Bluetooth Low Energy connectivity.

Short range radio such as Bluetooth Low Energy provides connectivity to devices within a specific local area efficiently. By reducing the communication distance, the sensor battery life is extended since the transmit power can be reduced. Furthermore, aggregating multiple local sensor data through a gateway reduces the cost of connectivity per sensor as they no longer need to be provided with a device key and a network key.



Secure Storage

With Bluetooth Low Energy and LoRa, storage providers can offer travelers secure temporary luggage lockers in train stations and airports. Typically, lockers are coin operated, and the traveler would remove the key after the required amount of coins are inserted. However, if the keys are lost, then the traveler must wait until they get a new key. For the storage provider, re-keying the locks is often an operational burden. Sometimes the lock may not re-key and the key is simply a straight replacement, which introduces a potential security risk.

“For the storage provider, re-keying the locks is often an operational burden. Sometimes the lock may not re-key and the key is simply a straight replacement, which introduces a potential security risk.”

An alternative solution to the physical lock-and-key system is to enable smartphone interaction with the locker over Bluetooth Low Energy. For example, a security token can be assigned to a traveler’s smartphone once they have paid the required fees. When the traveler wishes to open the locker, their smartphone interacts with the locker. An authentication check is performed at the back-end server and is communicated over LoRaWAN. If the security token matches, the locker opens.

Figure 9: Use Case: Authenticate, Action, and Notify

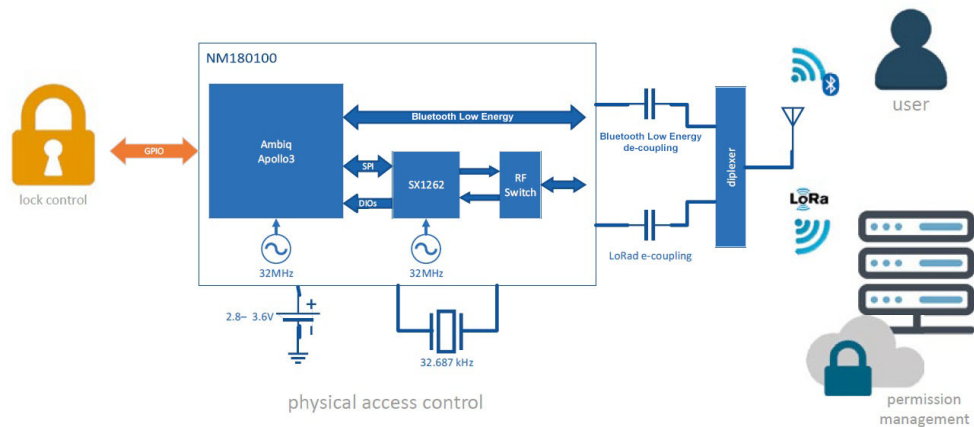

Security tokens eliminate the need for physical keys, streamlining the locker rental process for travelers. The use of tokens also simplifies maintenance, as there are no more physical keys to fix and replace. Since tokens can be revoked at any time without the need of hardware alteration to the lock, storage providers can enjoy a lower maintenance cost without sacrificing any security. In the wake of COVID-19, tokens offer an additional sanitary benefit, as the lack of physical keys exchanging between people minimizes the spread of infection.

Because tokens are provisioned to users over LoRaWAN, these lockers need to be equipped with an all-in-one hardware package that include an application processor, a Bluetooth Low Energy radio, and a LoRa radio. The NM180100 module is a perfect fit for these applications, as it streamlines user experience and simplifies maintenance. This concept is not only restricted to secured storage but can be easily adapted to any other physical access securities such as but not limited to door locks or delivery boxes.

Water Leak Detection

LoRa technology enables more proactive water leak detection in a variety of applications, including industrial monitoring and control, smart agriculture, smart buildings, smart cities, and smart factories. Traditionally, burst pipes and leaky valves go undetected until after damaged had occurred. If the leaks happen at night or in an area with low foot traffic, such as a basement, it could take hours or even days before the issue is made aware.

An emerging solution to prevent potential property damage that result from flooding and leaks is to use long range wireless sensors. These water leak sensors are compatible with Bluetooth Low Energy and LoRa technology, alerting industrial businesses with an immediate notification when a leak is detected. Additional sensors also offer valve control, meaning they can shut off any leaky valves without needing human input. Shutting off a valve immediately versus doing it hours later

can make a significant difference, potentially saving businesses thousands of dollars in repairs.

Figure 10: Use Case: Sense, Action, and Notify

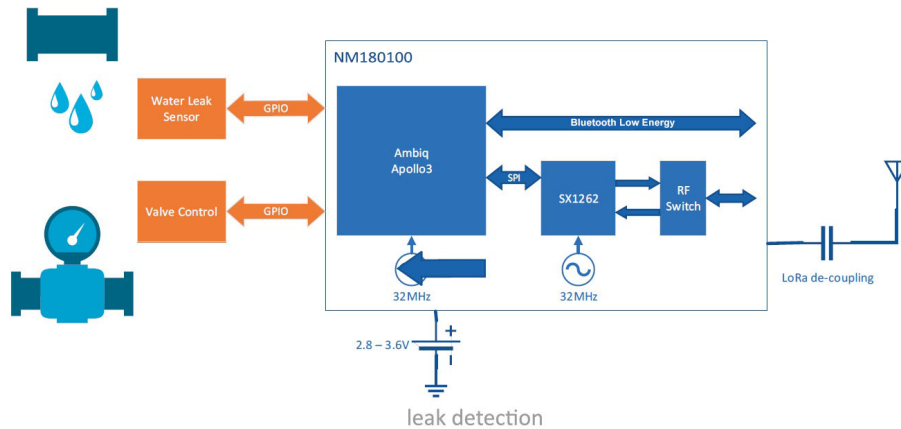

Since these sensors are often deployed in remote locations or difficult to access areas, it is important to combine them with a Bluetooth Low Energy and LoRa module that can send data reliably. Battery consumption is also a concern, as these IoT deployments are expected to last for years without replacement. Finally, the hardware must be able to operate in different environmental extremes with temperatures ranging from very hot to very cold.

A solution such as the NM180100 is ideal to meet all those demands. Not only can it be used for monitoring remote environments and detecting water pipe leaks, but it can be used for other applications, such as detecting frozen water pipes and the leakage of fuel or other dangerous liquids. The NM180100 also connects the sensors to the LoRaWAN network to send the periodic data including water leak events, ensuring businesses a greater peace of mind.



Cold Chain Monitoring

Finally, an area where Bluetooth Low Energy and LoRa can have a significant impact is in cold chain monitoring. Whether it is agricultural produce, chemicals, or biological samples, these perishable products must be maintained at a specified low-temperature range when being shipped.

Temperature and humidity sensors have automated the once manual tracking process, but many organizations lack the wireless communication infrastructure or the budget to monitor shipments in real-time.

However, asset tracking has become easier and more affordable with Bluetooth Low Energy tags, which provide real-time sensor telemetry such as location and environmental conditions. Environmental sensors such as the ones on the NM180310 are placed in the container, which monitor the temperature, humidity,

and volatile organic gases. They provide real-time data while accounting for patterns such as when/if the temperature spiked or dropped, how much it spiked/dropped, and for how long. When something unexpected occurs, the sensors trigger and send an automatic notification through the LoRaWAN network.

Figure 11: Use Case: Secure Biological Sample Access Control

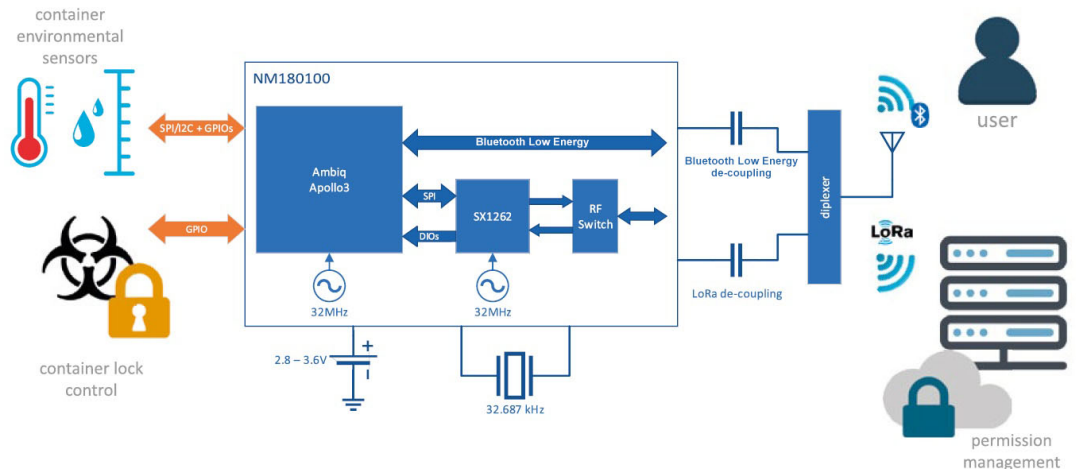

The robustness of LoRaWAN technology has enabled wireless sensors to better able handle the performance requirements of effective cold chain monitoring. Because LoRaWAN signals have strong penetration through thick walls, it outperforms alternative technologies in challenging cold chain environments. The robust RF performance of the NM180100 ensures a reliable wireless connection in a harsh RF environment. The NM180100 is an integral part of the wireless sensor system, helping the organization maintain quality and safety in cold chain management.

More effective cold chain management can improve the quality control, reduce damaged inventory, and improving risk mitigation. For pharmaceutical and medical organizations, these benefits make it easier to distribute experimental vaccines and therapeutics across both large urban areas and most remote locations. In the wake of the COVID-19 pandemic, these factors are especially relevant, as any potential vaccine or even biological samples for vaccine research must be continuously monitored in the cold chain.

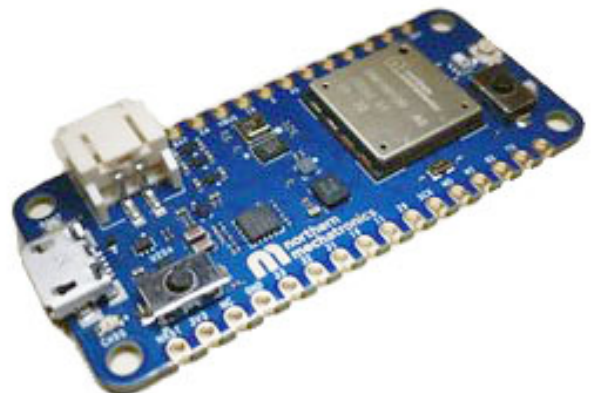

Choosing the Right OEM Partner for IoT Solution

IoT modules that can leverage Bluetooth Low Energy and LoRa technologies can be a cost-effective and ideal solution for companies. However, choosing the right Original Equipment Manufacturer (OEM) partner to deploy the IoT solution in an efficient and sustainable manner is needed. Here are the most crucial factors that should be considered when shopping for the right manufacturing partner for an IoT solution:



Scalability

Depending on the effectiveness of the existing IoT deployments, setting up additional endpoint devices within the network maybe needed. However, connecting new endpoints can become extremely complex as the amount of data generated and transmitted increase.

An IoT solution that can handle a vast amount of data is ideal if there are plans to scale up the IoT deployment at some point. Even if limited devices are currently being used, having an IoT partner with the capacity to handle more data can save businesses time and money in the future.



Energy Efficiency

Industrial IoT solutions must operate properly and switch seamlessly between multiple power sources such as the AC wall outlet and a backup battery. This ensures that the normal system operation is reliable no matter what power source is available.

However, remote IoT deployments must rely entirely on battery power, which needs to last for years to maximize operating time. For low-power IoT applications, the IoT solution needs to perform at the highest standards for energy efficiency. But with the right IoT module, businesses can enjoy direct energy savings across many use cases.

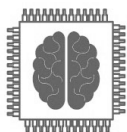

Edge Intelligence

The rise of edge computing means that your endpoint devices can compute more processes locally. However, to enable edge computing and intelligent endpoints, the IoT module needs to have a powerful microcontroller unit that can process data in real-time.

As real-time applications that need processing at the edge increase, so too will the number of intelligent endpoints that are deployed in the field. With the right edge-computing hardware, IoT devices can make cost-saving decisions on its own, such as shutting off water valves when a burst pipe is detected.



Cost

Depending on your specific deployment needs, you may need hundreds or even thousands of sensors, each equipped with a LoRaWAN gateway. Therefore, IoT sensor devices need to be cost effective to enable widespread deployment.

Setting up an IoT system can be a complex process, and the cost of deployment and maintenance can add up quickly, even if you do not have to pay for traditional infrastructure costs. As such, the IoT solution you choose needs to provide enough value to cover the cost of implementing and managing it.



Security

First-rate security is a must for cloud computing modules transmitting and receiving data on a regular basis. However, keeping the IoT solution secure is massively challenging due to the numerous use cases, types of network architectures, and different deployment options.

In certain applications, a breach in the IoT environment could leak information that is critical to how the business works or how a proprietary device is manufactured. To safeguard data against cyberattacks and potential breaches, the IoT partner should offer comprehensive tools, such as authentication methods, login access control, and end-to-end encryption.



Form Factor

To meet the environmental and performance demands of today's IoT deployments, the IoT module must have an ultra-small form factor and high-performance components. Despite a small form factor, the module needs to be compatible with standard wireless technologies, such as Wi-Fi, Bluetooth Low Energy, and LoRa.

For IoT deployments in extreme temperatures, such as cold supply chain management, the IoT module must be rugged enough to endure the extreme cold and protect from humidity and moisture. Industrial temperature tolerance is a necessity for many IoT applications today.

Conclusion

With the rapid expansion of the Internet of Things (IoT), digital sensors and networking technologies are increasingly utilized to connect devices and systems for more applications.

Among all the available wireless protocols, the most popular and prevalent technologies are Bluetooth Low Energy and LoRa (Long Range). The combination of Bluetooth Low Energy, which is intended for short-range networks, and LoRa, which is ideal for low power wide-area networks, is a perfect solution for easily and securely deploying IoT applications.

“The combination of Bluetooth Low Energy, which is intended for short-range networks, and LoRa, which is ideal for low power wide-area networks, is a perfect solution for easily and securely deploying IoT applications.”

As Bluetooth Low Energy and LoRa technologies emerged, IoT deployments were no longer limited to being near telecommunication towers. Complete wireless solutions for low-power IoT applications are now possible, which can provide organizations with significant benefits that include:

1. Real-time data
2. Optimized energy consumption
3. On-demand maintenance
4. High availability
5. Lower maintenance cost
6. Lower operating cost
7. Eliminated physical security keys
8. Easy remote installation
9. Streamlined user experience

This paper concludes that Northern Mechatronics’ new IoT wireless module, the NM180100, is perfectly suited for many vital applications that make use of Bluetooth Low Energy and LoRa. Powered by Ambiq’s ultra-low-power microcontroller, the Apollo3 Blue, this IoT solution can help companies innovate the IoT applications of the future.

“This paper concludes that Northern Mechatronics’ new IoT wireless module, the NM180100, is perfectly suited for many vital applications that make use of Bluetooth Low Energy and LoRa.”

About the Company

Northern Mechatronics

Northern Mechatronics was founded in 2017 with a focus to provide high performance, low power wireless communication modules, software, and solutions for the connected world.

With core competencies in RF and antenna design, Northern Mechatronics strives to enable developers – even ones without RF expertise – to build successful wireless products.

To learn more about Northern Mechatronics' IoT solution, visit www.northernmechatronics.com or email us at info@northernmechatronics.com.

Ambiq

Ambiq was founded in 2010 with the mission to foster a cleaner, greener, and safer environment where mobile and portable devices could either reduce or eliminate their total power consumption from the batteries. We laser-focused on inventing and delivering the most revolutionary system on chip (SoC) solutions in the market for the last ten years.

Through the advanced Subthreshold Power Optimized Technology (SPOT®) platform, Ambiq has helped many leading manufacturers worldwide create products that can operate for days, months, and sometimes years with a lithium battery or a single charge.

To learn more about how Ambiq's ultra-low-power processors can extend IoT solutions, visit www.ambiq.com or email us at marketing@ambiq.com.

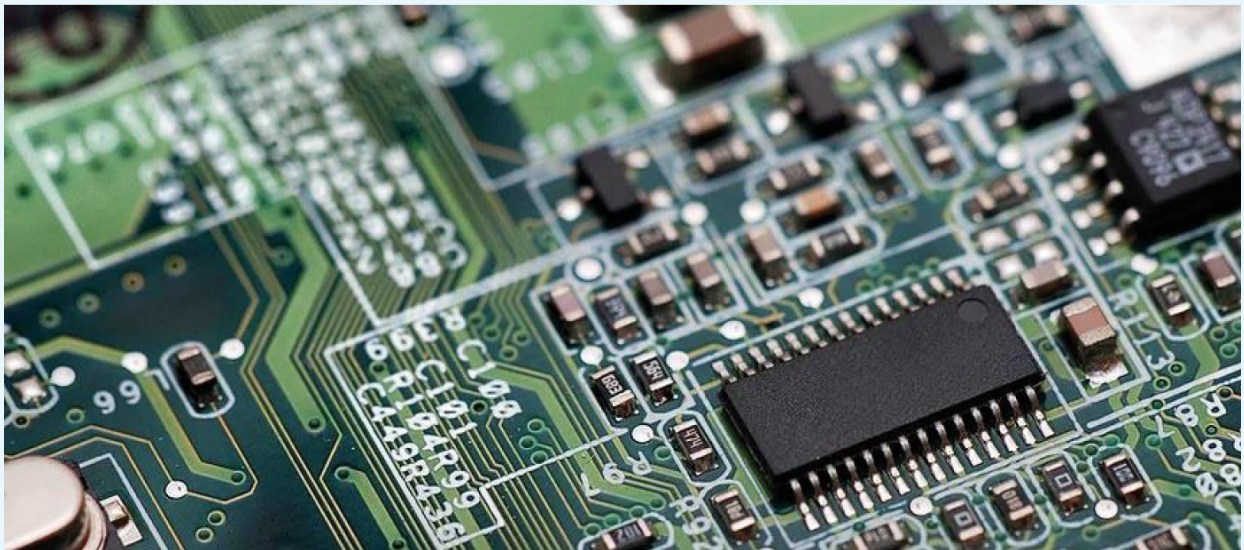



The Ambiq word mark and logos are registered trademarks of Ambiq Micro, Inc. The Bluetooth word mark and logos are registered trademarks owned by the Bluetooth SIG, Inc. and any use of such marks is under license. Other trademarks and trade names are those of their respective owners.

© 2023 Ambiq Micro, Inc. All rights reserved.

6500 River Place Boulevard, Building 7, Suite 200, Austin, TX 78730

www.ambiq.com

sales@ambiq.com

+1 (512) 879-2850

A-SOCA3B-WPGA01EN v1.2

January 2023