



QUICK START GUIDE

Apollo2 EVB Rev 1.1

Ultra-Low Power Apollo2 SoC Family

A-SOCAP2-QSGA01EN v2.0



Legal Information and Disclaimers

AMBIQ MICRO INTENDS FOR THE CONTENT CONTAINED IN THE DOCUMENT TO BE ACCURATE AND RELIABLE. THIS CONTENT MAY, HOWEVER, CONTAIN TECHNICAL INACCURACIES, TYPOGRAPHICAL ERRORS OR OTHER MISTAKES. AMBIQ MICRO MAY MAKE CORRECTIONS OR OTHER CHANGES TO THIS CONTENT AT ANY TIME. AMBIQ MICRO AND ITS SUPPLIERS RESERVE THE RIGHT TO MAKE CORRECTIONS, MODIFICATIONS, ENHANCEMENTS, IMPROVEMENTS AND OTHER CHANGES TO ITS PRODUCTS, PROGRAMS AND SERVICES AT ANY TIME OR TO DISCONTINUE ANY PRODUCTS, PROGRAMS, OR SERVICES WITHOUT NOTICE.

THE CONTENT IN THIS DOCUMENT IS PROVIDED "AS IS". AMBIQ MICRO AND ITS RESPECTIVE SUPPLIERS MAKE NO REPRESENTATIONS ABOUT THE SUITABILITY OF THIS CONTENT FOR ANY PURPOSE AND DISCLAIM ALL WARRANTIES AND CONDITIONS WITH REGARD TO THIS CONTENT, INCLUDING BUT NOT LIMITED TO, ALL IMPLIED WARRANTIES AND CONDITIONS OF MERCHANTABILITY, FITNESS FOR A PARTICULAR PURPOSE, TITLE AND NON-INFRINGEMENT OF ANY THIRD PARTY INTELLECTUAL PROPERTY RIGHT.

AMBIQ MICRO DOES NOT WARRANT OR REPRESENT THAT ANY LICENSE, EITHER EXPRESS OR IMPLIED, IS GRANTED UNDER ANY PATENT RIGHT, COPYRIGHT, MASK WORK RIGHT, OR OTHER INTELLECTUAL PROPERTY RIGHT OF AMBIQ MICRO COVERING OR RELATING TO THIS CONTENT OR ANY COMBINATION, MACHINE, OR PROCESS TO WHICH THIS CONTENT RELATE OR WITH WHICH THIS CONTENT MAY BE USED.

USE OF THE INFORMATION IN THIS DOCUMENT MAY REQUIRE A LICENSE FROM A THIRD PARTY UNDER THE PATENTS OR OTHER INTELLECTUAL PROPERTY OF THAT THIRD PARTY, OR A LICENSE FROM AMBIQ MICRO UNDER THE PATENTS OR OTHER INTELLECTUAL PROPERTY OF AMBIQ MICRO.

INFORMATION IN THIS DOCUMENT IS PROVIDED SOLELY TO ENABLE SYSTEM AND SOFTWARE IMPLEMENTERS TO USE AMBIQ MICRO PRODUCTS. THERE ARE NO EXPRESS OR IMPLIED COPYRIGHT LICENSES GRANTED HEREUNDER TO DESIGN OR FABRICATE ANY INTEGRATED CIRCUITS OR INTEGRATED CIRCUITS BASED ON THE INFORMATION IN THIS DOCUMENT. AMBIQ MICRO RESERVES THE RIGHT TO MAKE CHANGES WITHOUT FURTHER NOTICE TO ANY PRODUCTS HEREIN. AMBIQ MICRO MAKES NO WARRANTY, REPRESENTATION OR GUARANTEE REGARDING THE SUITABILITY OF ITS PRODUCTS FOR ANY PARTICULAR PURPOSE, NOR DOES AMBIQ MICRO ASSUME ANY LIABILITY ARISING OUT OF THE APPLICATION OR USE OF ANY PRODUCT OR CIRCUIT, AND SPECIFICALLY DISCLAIMS ANY AND ALL LIABILITY, INCLUDING WITHOUT LIMITATION CONSEQUENTIAL OR INCIDENTAL DAMAGES. "TYPICAL" PARAMETERS WHICH MAY BE PROVIDED IN AMBIQ MICRO DATA SHEETS AND/OR SPECIFICATIONS CAN AND DO VARY IN DIFFERENT APPLICATIONS AND ACTUAL PERFORMANCE MAY VARY OVER TIME. ALL OPERATING PARAMETERS, INCLUDING "TYPICALS" MUST BE VALIDATED FOR EACH CUSTOMER APPLICATION BY CUSTOMER'S TECHNICAL EXPERTS. AMBIQ MICRO DOES NOT CONVEY ANY LICENSE UNDER NEITHER ITS PATENT RIGHTS NOR THE RIGHTS OF OTHERS. AMBIQ MICRO PRODUCTS ARE NOT DESIGNED, INTENDED, OR AUTHORIZED FOR USE AS COMPONENTS IN SYSTEMS INTENDED FOR SURGICAL IMPLANT INTO THE BODY, OR OTHER APPLICATIONS INTENDED TO SUPPORT OR SUSTAIN LIFE, OR FOR ANY OTHER APPLICATION IN WHICH THE FAILURE OF THE AMBIQ MICRO PRODUCT COULD CREATE A SITUATION WHERE PERSONAL INJURY OR DEATH MAY OCCUR. SHOULD BUYER PURCHASE OR USE AMBIQ MICRO PRODUCTS FOR ANY SUCH UNINTENDED OR UNAUTHORIZED APPLICATION, BUYER SHALL INDEMNIFY AND HOLD AMBIQ MICRO AND ITS OFFICERS, EMPLOYEES, SUBSIDIARIES, AFFILIATES, AND DISTRIBUTORS HARMLESS AGAINST ALL CLAIMS, COSTS, DAMAGES, AND EXPENSES, AND REASONABLE ATTORNEY FEES ARISING OUT OF, DIRECTLY OR INDIRECTLY, ANY CLAIM OF PERSONAL INJURY OR DEATH ASSOCIATED WITH SUCH UNINTENDED OR UNAUTHORIZED USE, EVEN IF SUCH CLAIM ALLEGES THAT AMBIQ MICRO WAS NEGLIGENT REGARDING THE DESIGN OR MANUFACTURE OF THE PART.

Revision History

Revision	Date	Description
1.0	August 2017	Initial release
2.0	January 10, 2023	Updated document template

Reference Documents

Document ID	Description

Table of Contents

1 Introduction	5
2 Overview of Apollo2 EVB	6
3 Debug Interface	7
4 Software Development Tools for the Apollo2 EVB	9
5 Power Supply Options and Measuring Current	10

SECTION

1

Introduction

This document provides guidance in setting up the Apollo2 Evaluation Board (EVB), revision 1.1, to get started executing code examples, measuring power consumption in various configurations, and beginning software development.

SECTION

2

Overview of Apollo2 EVB

The Apollo2 EVB features Arduino-compatible headers and an integrated J-Link debugger:

Figure 2-1: Apollo2 EVB, Revision 1.1

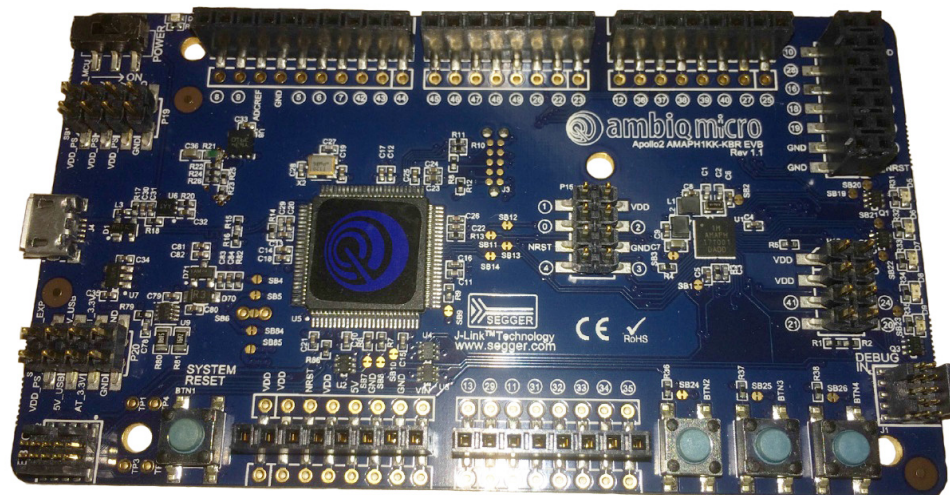

The EVB has these additional features:

- Low power reference design
- Apollo2 SoC in the BGA package (AMAPH1KK-KBR)
- Multiple power/clock options
- Micro USB connector for power/download/debug
- Segger J-Link debugger
- Debugger-in / debugger-out ports
- Five user-controlled LEDs
- Three push buttons for application use, plus a reset push button
- Power slide switch with LED power indicator
- Five 8-12 pin Arduino-style headers for pin/power access to shield board(s)
- Multiple test points for power measurements
- CE Mark and RoHS compliant

SECTION

3

Debug Interface

Figure 3-1 shows the Apollo2 EVB set up for standard debug using the on-board J-Link debugger and onboard power supply configured for 3.3V.

Figure 3-1: Apollo2 EVB Using On-board J-Link Debugger

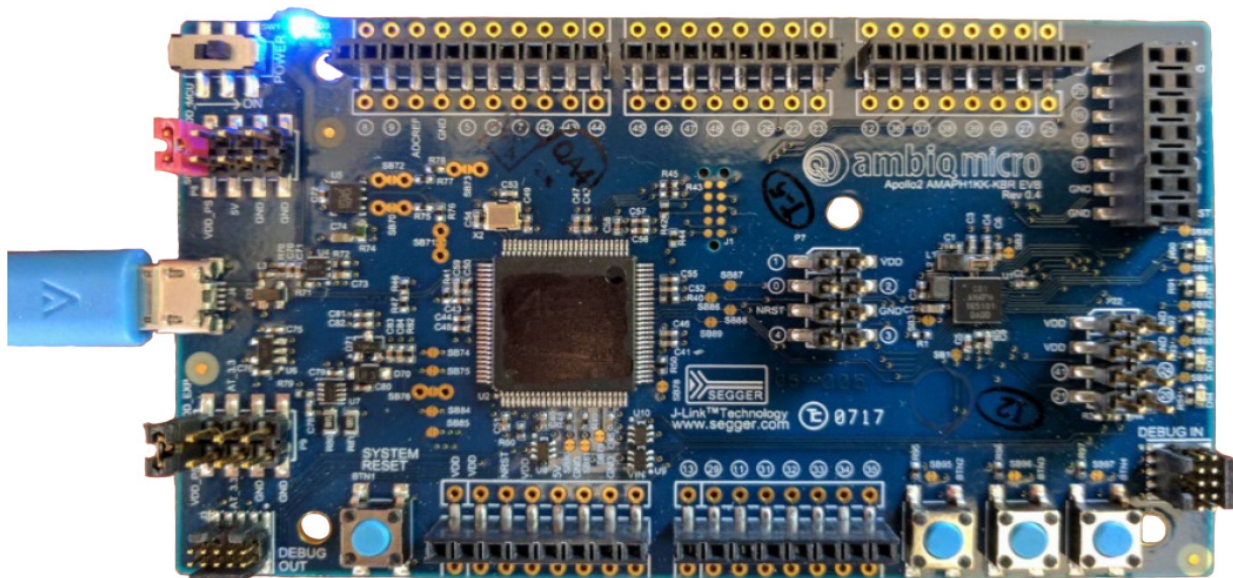

The debug interface is supported by standard J-Link drivers from Segger. Refer to *Section 4 Software Development Tools for the Apollo2 EVB* on page 9 for more details on J-Link debug support.

This EVB also supports the use of an external Cortex SWD debug interface through a standard 10-pin debug header (DEBUG IN - J1) as shown in Figure 3-2 on page 8.

Figure 3-2: Apollo2 EVB's Cortex DEBUG IN Header (J1)

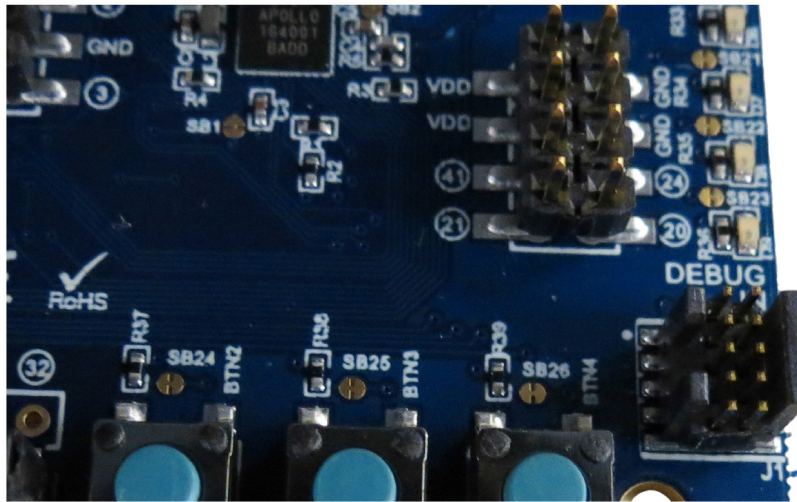

No jumper changes are required to use an external debug adapter. Simply connect the external debug adapter with a 10-pin ribbon cable connector to the **DEBUG IN** header.

The EVB also offers the ability to be used as a J-Link debug adapter for any target board that has an Apollo family SoC (Apollo or Apollo2).

Figure 3-3: Apollo2 EVB's DEBUG OUT Header (J2)

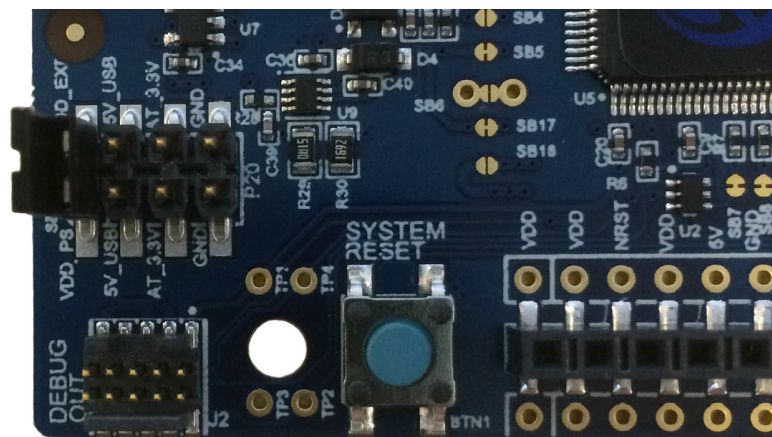

To utilize this functionality, use a 10-pin low-pitch standard debug connector to connect the **DEBUG OUT** header (J2) on the EVB to the debug header on the target board. The EVB will automatically detect when the **DEBUG OUT** header is connected to another target board and reconfigure the integrated J-Link to connect to this external board rather than the onboard Apollo2.

NOTE: A voltage on pin 1 of the J2 header is required for the above mentioned automatic switch to occur. Also, if the target VDD does not match the onboard voltage (either 3.3V or 2.1V), and to avoid possible voltage level conflicts on the debug I/O port, VDDIO of the J-Link processor may need to be changed to the target voltage by cutting SB5 and shorting SB6.

SECTION

4

Software Development Tools for the Apollo2 EVB

The standard Segger J-Link debug interface is used on the Apollo2 EVB. Install the latest Beta Segger J-Link software, and configure your preferred development IDE (Keil, IAR, or Eclipse) to use J-Link debug interface.

Links to development tools that support Apollo2:

- SEGGER J-Link Software (6.14 or newer):
<https://www.segger.com/downloads/jlink>
- KEIL uVision MDK523 or newer:
<https://www.keil.com/demo/eval/arm.htm>
- New Keil Pack (Also used by Eclipse) at:
<http://www.keil.com/dd2/pack/#/third-party-download-dialog>
- IAR Version 7.80.4 or 8.10.1 or newer:
<https://www.iar.com/iar-embedded-workbench/tools-for-arm/armcortex-m-edition/>

Regardless of preferred IDE, install the Segger J-Link software. All three of the above development environments support J-Link, but you must have the latest J-Link software installed. Most alternate development environments also are supported by J-Link.

Refer to the *AmbiqSuite Getting Started Guide* (AMSDKGS) for more details on setting up development IDEs to use J-Link.

SECTION

5

Power Supply Options and Measuring Current

There are three power supply options for the Apollo2 EVB:

- Operate at 3.3V as provided by the onboard power supply
- Operate at 2.1V as provided by the onboard power supply
- Provide externally supplied power

Figure 5-1 shows header P19 which is used to select a power configuration through jumper installations, as well as the option to measure the supply current to the SoC with an ammeter. Solder bridge SB15 can be filled instead of jumpering from pin 1 to pin 2 if current measuring is of no interest.

Figure 5-1: Voltage Selection on Header P19

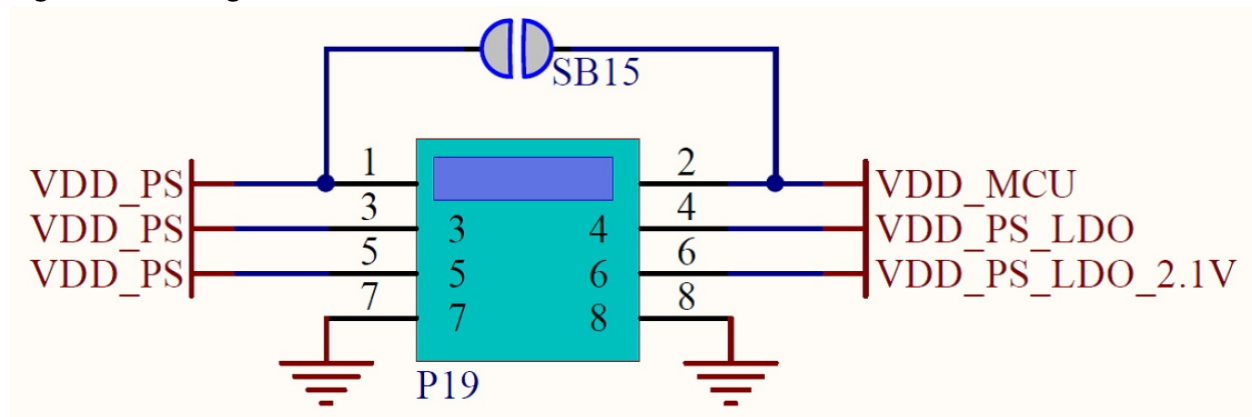

Table 5-1 on page 11 shows valid jumper configurations for P19. All other configurations are invalid. Note that a jumper across pins 7 and 8 is not necessary and does not do anything - the pins are available only for easy access to ground.

Table 5-1: Jumper Configuration for Power Selections

Jumper 1-2	Jumper 3-4	Jumper 5-6	Power Source
In	In	Out	3.3V operation from internal regulator
In	In	In	2.1V operation from internal regulator
Out	In	Out	Intended for current measuring across pins 1 and 2 during 3.3V operation from internal regulator
Out	In	In	Intended for current measuring across pins 1 and 2 during 2.1V operation from internal regulator
In	Out	Out	Externally-provided supply voltage within the allowable range (1.8-3.8V) on pin 3 or 5
Out	Out	Out	Intended for current measuring across pins 1 and 2 during externally-provided supply voltage within the allowable range (1.755-3.60V) on pin 3 or 5

As an example for setting the jumpers on P19, Figure 5-2 shows the EVB configured for 3.3V operation with jumper across VDD_PS and VDD_MCU for no current measurement.

Figure 5-2: Header P19 Configured for 3.3V Operation - No Current Measurement

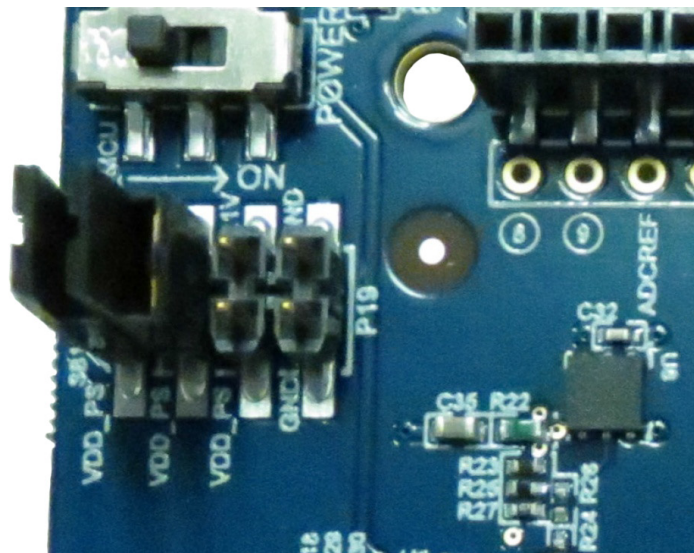
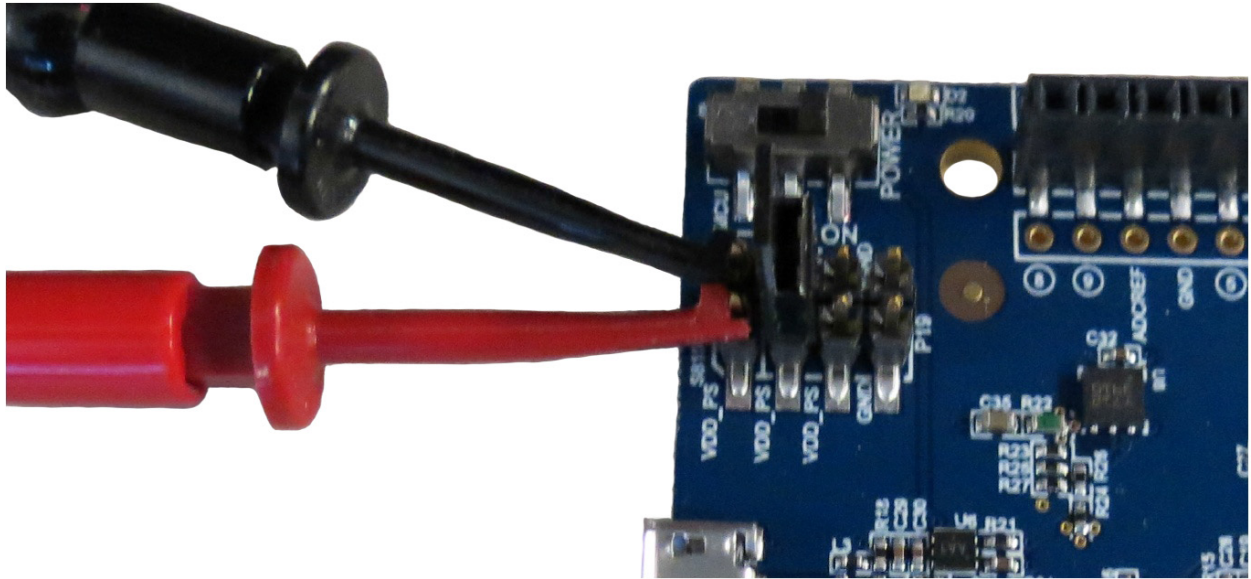

Figure 5-3 on page 12 shows the EVB configured for 3.3V operation with current measuring leads across VDD_PS and VDD_MCU for current measurement.

Figure 5-3: Header P19 Configured for 3.3V Operation - With Current Measurement





© 2023 Ambiq Micro, Inc. All rights reserved.

6500 River Place Boulevard, Building 7, Suite 200, Austin, TX 78730

www.ambiq.com

sales@ambiq.com

+1 (512) 879-2850

A-SOCAP2-QSGA01EN v2.0

January 2023